

pipetman®

Pipette Replacement Parts

EN



 **GILSON®**



TABLE OF CONTENTS

REPLACEMENT PARTS | 3

PIPETMAN® Fixed | 4

PIPETMAN® Neo | 4

PIPETMAN® G | 5

PIPETMAN® L | 6

PIPETMAN® L Fixed | 7

PIPETMAN® M | 8

MICROMAN® | 9

DISTRIMAN® | 9

REPLACEMENT PARTS



Spare parts manufactured by Gilson are products of thorough research and stringent quality control, guaranteed to deliver value and assure reliability and precision.

Having your pipettes regularly serviced by a Gilson certified and audited service center, staffed by qualified technicians and using genuine Gilson spare parts, is the best way to guarantee high performance and trouble-free pipetting.

Gilson spare parts are only available from your local, authorized Gilson representative.

PIPETMAN® Classic

PIPETMAN Classic

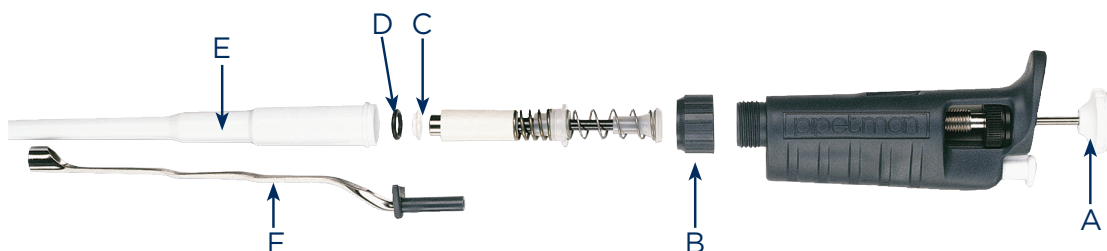

PIPETMAN Classic - Updated Version

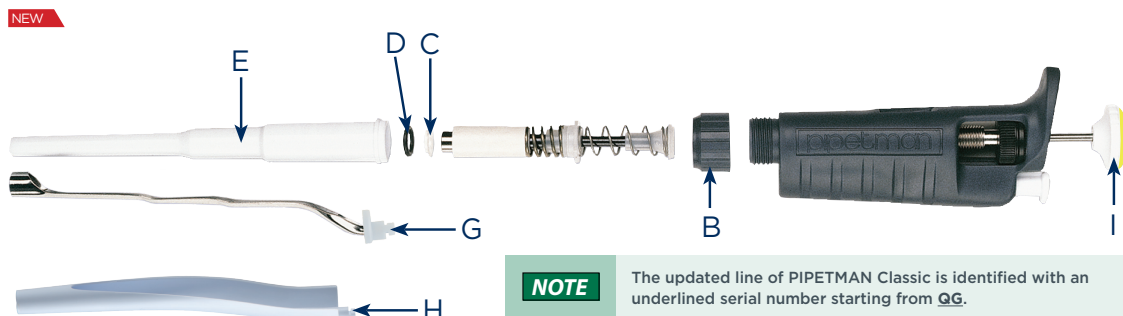

NOTE The updated line of PIPETMAN Classic is identified with an underlined serial number starting from QG.

PIPETMAN® Classic Service Kits	Ordering Part Numbers								
	Key	P2	P10	P20	P100	P200	P1000	P5000	P10mL
Service kit 1 st level (1 tip holder, 3 piston seals and 3 O-rings)	C+D+E	F144501	F144502	F144495	F144496	F144497	F144498	F144499**	F144503
Service kit 2 nd level (1 push button, 1 connecting nut, 1 tip ejector and 1 tip ejector adapter only for PIPETMAN P2/P10)	A+B+F	F161970	F161971	F161972	F161973	F161974	F161978	*	
NEW Service kit 2 nd level (1 connecting nut, 1 Dual-position adapter only for PIPETMAN P2/P10, 1 push button, and 1 metal ejector)	B+I+G	F107012	F107013	F107014	F107015	F107016	F107017	*	

*Not applicable with this model. Refer to the User's Guide (LT801120) for details.

**Only two piston seals and O-ring.

PIPETMAN® Classic Replacement Parts	Ordering Part Numbers								
	Key	P2	P10	P20	P100	P200	P1000	P5000	P10mL
Push button	A	*						F144787	F161281
NEW Push button (PIPETMAN Classic Updated version)	I	**						F107009	F107010
Piston seal & O-ring (5 sets)	C+D	F144861	F144862	F144863	F144864	F144865	F144866	F144867	F161829
Tip holder	E	*						F123608	F161263
Dual-position adapter (5 sets)	**	F144879	F144879	*					
NEW Tip ejector extension	**	F2070903	F2070903	*					
NEW Plastic ejector	H	F107027	F107027	F107028	F107029	F107030	F107031	*	
Bags of 10 filters	**	*						F161280	F161280
Bags of 100 filters	**	*						F161241	F161241

*Not applicable with this model.

**Not shown. Refer to the User's Guide (LT801120) for details.



PIPETMAN® Fixed

PIPETMAN® Fixed Service Kits		Ordering Part Numbers				
Item	F2 to F20	F25 to F100	F200	F250 to F1000	F5000	
Service kit 1 st level (1 tip holder, 3 piston seals and 3 O-rings)	F144495	F144496	F144497	F144498	F144499*	

*Only two piston seals and O-ring.

PIPETMAN® Fixed Replacement Parts		Ordering Part Numbers				
Item	F2 to F20	F25 to F100	F200	F250 to F1000	F5000	
Piston assembly	F123845	F144611	F123846	F123847	F123848	
Piston seal & O-ring (5 sets)	F144863	F144864	F144865	F144866	F144867	
Connecting Nut	F144723	F144723	F144723	F144723	*	
Tip ejector	F144766	F144767	F144768	F144769	*	
Adjustment key	F123674	F123674	F123674	F123674	F123674	
Bags of 10 filters	*				F161280	
Bags of 100 filters	*				F161241	

*Not applicable with this model. Refer to the User's Guide (LT801118) for details



PIPETMAN® Neo

PIPETMAN Neo Single Channel

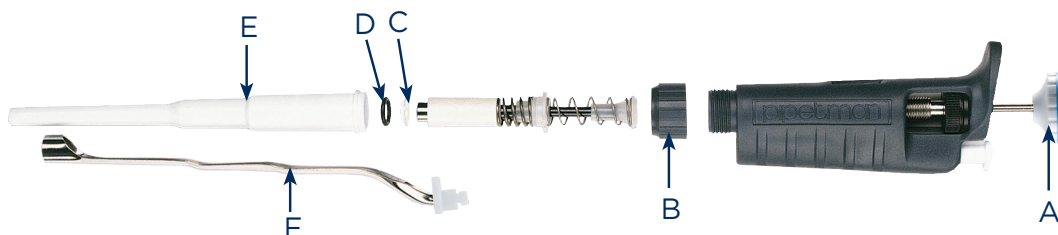

PIPETMAN® Neo Service Kits		Ordering Part Numbers						
Item	Key	P2N	P10N	P20N	P100N	P200N	P1000N	
Service kit 1 st level (1 tip holder, 3 piston seals and 3 O-rings)	C+D+E	F144501	F144502	F144495	F144496	F144497	F144498	
Service kit 2 nd level (1 push button, 1 connecting nut, 1 tip ejector and 1 tip ejector adapter only for PIPETMAN P2N/P10N)	A+B+F	F1619701	F1619711	F1619721	F1619731	F1619741	F1619781	

*Not applicable with this model.

**Not shown. Refer to the User's Guide (LT801521) for details.

PIPETMAN® Neo Replacement Parts		Ordering Part Numbers						
Item	Key	P2N	P10N	P20N	P100N	P200N	P1000N	
Piston seal & O-ring (5 sets)	C+D	F144861	F144862	F144863	F144864	F144865	F144866	
Tip holder	E	*						
Plastic ejector	**	F107027	F107027	F107028	F107029	F107030	F107031	
Dual-position adapter (5 sets)	**	F144879	F144879	*				
Tip ejector extension	**	F2070903	F2070903					

*Not applicable with this model.

**Not shown. Refer to the User's Guide (LT801521) for details.

PIPETMAN Neo Multichannel

PIPETMAN® Neo Multichannel Replacement Parts		Ordering Part Numbers				
Item	Key	P8x20N	P12x20N	8Px200N	P12x200N	
Tip ejector	A	F507005	F507006	F507005	F507006	
Ejector lock	B	F507008	F507008	F507008	F507008	
Ejector spacer	C	F507001	F507003	F507001	F507003	

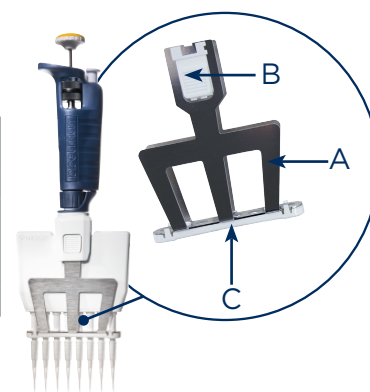

PIPETMAN® G

PIPETMAN G Single Channel

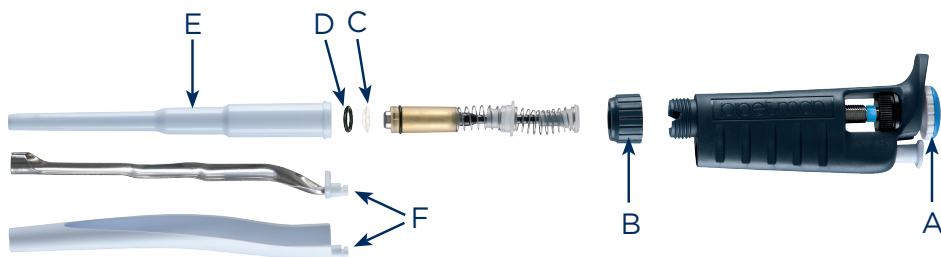

PIPETMAN® G Service Kits		Ordering Part Numbers							
Item	Key	P2G	P10G	P20G	P100G	P200G	P1000G	P5000G	P10mLG
Service kit 1 st level (1 tip holder, 3 seals guide and 3 O-rings)	C+D+E	F144501	FA07001	FA07002	FA07003	FA07004	FA07005	FA07021**	FA07022
Service kit 2 nd level (1 push button, 1 connecting nut, 1 stainless steel ejector, 1 plastic ejector, 2 ejector adapters respectively for metal and plastic PIPETMAN P2G/P10G)	A+B+F	F1619702	F1619712	F1619722	F1619732	F1619742	F1619782	*	*

*Not applicable with this model. Refer to the User's Guide (LT801122) for details.

**Only two piston seals and O-ring.

PIPETMAN® G Replacement Parts		Ordering Part Numbers							
Item	Key	P2G	P10G	P20G	P100G	P200G	P1000G	P5000G	P10mLG
NEW Push button	A							F107009	F107010
Seal guide & O-ring (5 sets)	C+D	F144861	FA07012	FA07013	FA07014	FA07015	FA07016	FA07017	FA07018
Dual-position adapter (5 sets)	**	F144879	F144879						
Tip ejector extension	**	F2070903	F2070903						
NEW Plastic ejector	**	F107027	F107027	F107028	F107029	F107030	F107031	*	*
NEW Tip holder	**							F123608	F161263
NEW Bag of 10 filters	**							F161280	F161280
Lubricant	**	5440011070							

*Not applicable with this model.

**Not shown. Refer to the User's Guide (LT801120) for details.

PIPETMAN G Multichannel

NEW

PIPETMAN G Multichannel Replacement Parts		Ordering Part Numbers							
Item	Key	P8x10G	P12x10G	P8x20G	P12x20G	P8x200G	P12x200G	P8x300G	P12x300G
Tip ejector	A	F507005	F507006	F507005	F507006	F507005	F507006	F507005	F507006
Ejector lock	B	F507008	F507008	F507008	F507008	F507008	F507008	F507008	F507008
Ejector spacer	C	F507001	F507003	F507001	F507003	F507001	F507003	F507001	F507003
Ejector spacer D10	D	F807114	F807115	*					

*Not applicable with this model. Refer to the User's Guide (LT801120) for details.

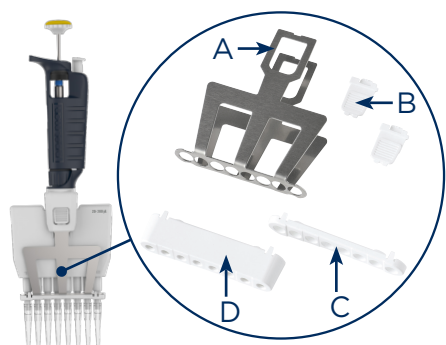



PIPETMAN® L

PIPETMAN L Single Channel

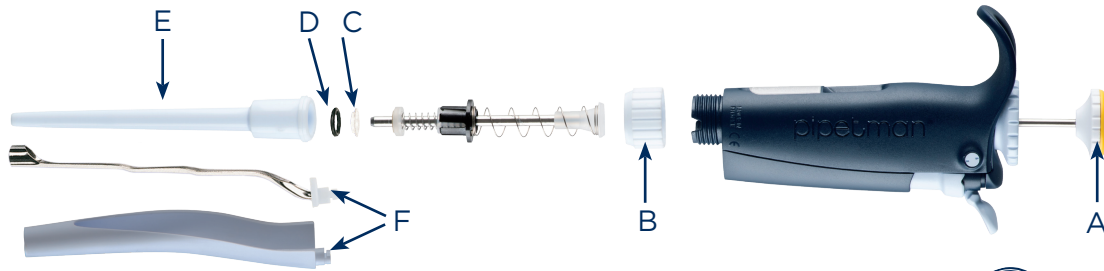

Autoclavable

PIPETMAN L Service Kits		Ordering Part Numbers							
Item	Key	P2L	P10L	P20L	P100L	P200L	P1000L	P5000L	P10mLL
Service kit 1 st level (1 tip holder, 3 seals guide and 3 O-rings)	C+D+E	F144501	FA07001	FA07002	FA07003	FA07004	FA07004	FA07021**	FA07022
	Autoclavable	F144501	FA07001	FA07002	FA07003	FA07004	FA07004	FA07311**	FA07312
Service kit 2 nd level (1 push-button, 1 connecting nut, 1 stainless steel ejector, 1 plastic ejector, 2 ejector adapters, respectively for metal and plastic PIPETMAN P2L/P10L/P2LA/P10LA)	A+B+F	FA07006	FA07007	FA07008	FA07009	FA07010	FA07011	*	
	Autoclavable	FA07301	FA07302	FA07303	FA07304	FA07305	FA07306	*	

*Not applicable with this model. Refer to the User's Guide (LT801575) for details.
 ** Only two seals guide and O-ring.

NOTE All pipettes with a serial number starting with NK are fully autoclavable. Refer to the User's Guide (LT801575) for details.

PIPETMAN L Replacement Parts		Ordering Part Numbers							
Item	Key	P2L	P10L	P20L	P100L	P200L	P1000L	P5000L	P10mLL
Push Button	**	*						F107009	F107010
Seal guide & O-ring (5 sets)	C+D	F144861	FA07012	FA07013	FA07014	FA07015	FA07016	FA07017	FA07018
	Autoclavable	F144861	FA07012	FA07013	FA07014	FA07015	FA07016	FA07307	FA07308
Dual-position adapter (5 sets)	**	F144879	F144879	*					
Tip ejector extension	**	F2070903	F2070903	*					
Plastic ejector	**	F107027	F107027	F107028	F107029	F107030	F107031	*	
Tip holder	E	*						F123608	F161263
Bag of 10 filters	**	*						F161280	F161280
Lubricant	**	5440011070							

*Not applicable with this model.
 **Not shown. Refer to the User's Guide (LT801575) for details.

NOTE All pipettes with a serial number starting with NK are fully autoclavable. Refer to the User's Guide (LT801575) for details.

PIPETMAN L Multichannel

PIPETMAN L Multi Replacement Parts		Ordering Part Numbers							
Item	Key	P8x10L	P8x20L	P12x10L	P12x20L	P8x200L	P8x300L	P12x200L	P12x300L
Tip ejector	G	F507005	F507005	F507006	F507006	F507005	F507005	F507006	F507006
Ejector lock	H	F507008	F507008	F507008	F507008	F507008	F507008	F507008	F507008
Ejector spacer	I	F507001	F507001	F507003	F507003	F507001	F507001	F507003	F507003
Ejector spacer D10	J	F807114	F807114	F807115	F807115	*			

*Not applicable with this model. Refer to the User's Guide (LT801575) for details.

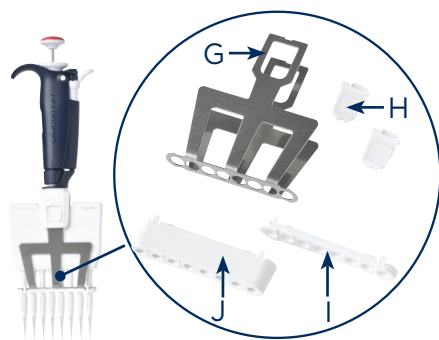

PIPETMAN® L Fixed

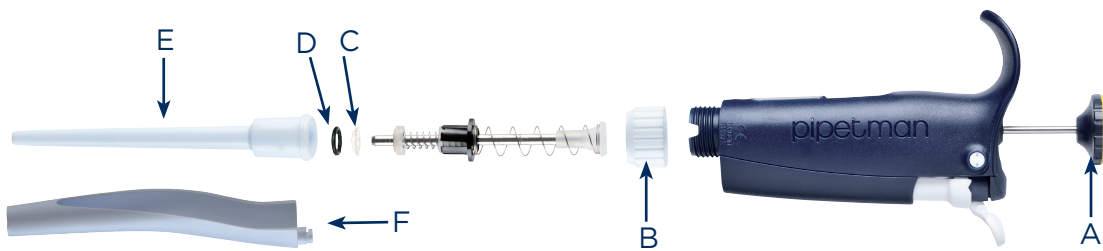

PIPETMAN® L Fixed Service Kits		Ordering Part Numbers							
Item	Key	FIL/F2L	F5L/F10L	F20L/F25L	F50L/F100L	F200L	F250L	F300L/F400L/ F500L/F1000L	F5000L
Service kit 1 st level (1 tip holder, 3 seals guide and 3 O-rings)	C+D+E	F144501	FA07001	FA07002	FA07003	FA07004	FA07004	FA07005**	FA07021
Service kit 2 nd level (1 push button, 1 connecting nut, 1 plastic tip ejector, 1 tip ejector extension for FIL, F2L, F5L, F10L)	A+B+F	FA07067	FA07068	FA07069	FA07070	FA07071	FA07073	FA07072	*

*Not applicable with this model. Refer to the User's Guide (LT801575) for details.

**Only two pistons seals and O-ring.

PIPETMAN® L Fixed Replacement Parts		Ordering Part Numbers						
Item	Key	FIL/F2L	F5L/F10L	F20L/F25L	F50L/F100L	F200L/F250L	F300L/F400L/ F500L/F1000L	F5000L
Seals guide & O-ring (5 sets)	C+D	*	FA07012	FA07013	FA07014	FA07015	FA07016	FA07017
Tip ejector extension	**	F2070903	F2070903	*				
Lubricant	**	5440011070						

*Not applicable with this model.

**Not shown. Refer to the User's Guide (LT801575) for details.





PIPETMAN® M and PIPETMAN® M Connected

PIPETMAN M Single Channel

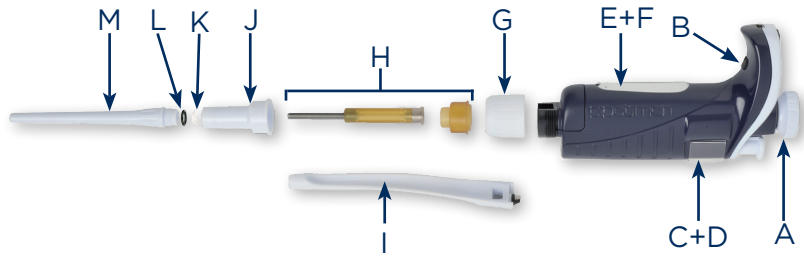

PIPETMAN® M Single Replacement Parts	Ordering Part Numbers								
	Key	P10M	P20M	P100M	P200M	P300M	P1200M	P5000M	P10mLM
Connecting nut	G	F807012	F807012	F807012	F807012	F807012	F807012	F807012	F807012
Battery tag, 1x4	C+D	F807013	F807013	F807013	F807013	F807013	F807013	F807013	F807013
Ejector tag, 1x4	E+F	F807014	F807014	F807014	F807014	F807014	F807014	F807014	F807014
Power supply USB	**	F807015	F807015	F807015	F807015	F807015	F807015	F807015	F807015
Power tub cover	B	F807022	F807022	F807022	F807022	F807022	F807022	F807022	F807022
Battery window	C+D	F807005	F807005	F807005	F807005	F807005	F807005	F807005	F807005
Ejector window	E+F	F807006	F807006	F807006	F807006	F807006	F807006	F807006	F807006
Lubrican tube 3.5g	**	**	F3070902	F3070902	F3070902	F3070902	F3070902	F3070902	F3070902
Seal, 1x5	K	F161902	*						
Seal & O-Ring, 5 sets	L+K	*	F144863	*					
O-ring, 1x5	L	*	F807146		F2070501	F807134	F807152	F807148	F807149
Tip holder, upper part	J	F2070117	F2070117	F807135	F2070517	F2070517	F2070617	**	**
Tip holder, lower part	M	F2070218	F2070318	F807136	F2070518	F807153	F2070618	F2070719	F807147
Button assembly	A	F807141	F807142	F807119	F807143	F807120	F807121	F807122	F807123
Tip ejector assembly	I	F807008	F807009	F807130	F807010	F807010	F807011	F807131	F807132
Piston assembly	H	F807017	F807018	F807126	F807019	F807127	F807020	F807128	F807129

* Not applicable with this model.

**Not shown. Refer to the User's Guide (LT801563) for details.

PIPETMAN M Multichannel

PIPETMAN® M Multi Replacement Parts	Ordering Part Numbers												
	Key	P8X10M	P12X10M	P8X20M	P12X20M	P8X100M	P12X100M	P8X200M	P12X200M	P8X300M	P12X300M	P8X1200M	12X1200M
Battery tag, 1x4	C+D	F807013	F807013	F807013	F807013	F807013	F807013	F807013	F807013	F807013	F807013	F807013	F807013
Ejector tag, 1x4	E+F	F807014	F807014	F807014	F807014	F807014	F807014	F807014	F807014	F807014	F807014	F807014	F807014
Power supply USB	**	F807015	F807015	F807015	F807015	F807015	F807015	F807015	F807015	F807015	F807015	F807015	F807015
Power tub cover	B	F807022	F807022	F807022	F807022	F807022	F807022	F807022	F807022	F807022	F807022	F807022	F807022
Battery window	C+D	F807005	F807005	F807005	F807005	F807005	F807005	F807005	F807005	F807005	F807005	F807005	F807005
Ejector window	E+F	F807006	F807006	F807006	F807006	F807006	F807006	F807006	F807006	F807006	F807006	F807006	F807006
Button assembly	A	F807141	F807141	F807144	F807144	F807124	F807124	F807143	F807143	F807145	F807145	F807125	F807125
Ejector spacer	N	F507001	F507003	F507001	F507003	F507001	F507003	F507001	F507003	F507001	F507003	F507139	F507140
Ejector spacer D10	Q	F807117	F807118	*									
Ejector lock	O	F507008	F507008	F507008	F507008	F507008	F507008	F507008	F507008	F507008	F507008	F507008	F507008
Tip ejector assembly	P	F507005	F507006	F507005	F507006	F507005	F507006	F507005	F507006	F507005	F507006	F507137	F507138

* Not applicable with this model.

**Not shown. Refer to the User's Guide (LT801563) for details.

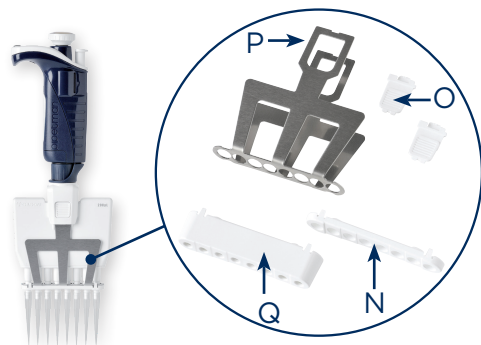

MICROMAN®

MICROMAN® Replacement Parts	
Item	Ordering Part Numbers
Button assembly, blue, M10	F148568
Button assembly, blue, M100	F148569
Button assembly, blue, M25	F148615
Button assembly, blue, M50	F148616
Button assembly, blue, M250	F148618
Button assembly, blue, M1000	F148619



Refer to the User's Guide (LT801502) for details.

DISTRIMAN®

DISTRIMAN® Replacement Parts	
Item	Ordering Part Numbers
Push button assembly	F164040
Piston retaining assembly	F164070
Red flag (set of 5)	F164042
Retaining spring	F1864052



Refer to the User's Guide (LT801285) for details



